

ITEM NO.	PART NUMBER	REVISION	DESCRIPTION	QTY
1	NDN043-44-Set	REL-01	Tec 800 Series Handle Assy	1
2	ADD042	REL-01	15mm Heater Housing Assy.	1
3	NDN050	REL-02	15mm Glue Carrier	1
4	ADD049	REL-01	Metal Feed Cam / Spring Assy	1
5	NDN047	REL-01	Trigger Link	1
6	NDN046	REL-01	Trigger	1
7	NDN051	REL-01	Thermostat Cover - Right Hand	1
8	NDN052	REL-01	Thermostat Cover - Left Hand	1
9	NDN045	REL-01	Stand	1
10	NDN053	REL-01	Side Stand-Off	2
11	PA1550	REL-02	Moulded Spacer	2
12	PA3036	REL-01	Cord Clamp	1
13	NDR011	REL-01	Nozzle Guard	1
14	PA1542	REL-02	Front Grommet	1
15	NDR013	REL-01	Rear Grommet	1
16	AED049	REL-01	Heater Assy. 230V 300W	1
17	AED050	REL-01	Heater Assy. 120V 300W	1
18	AED051	REL-01	Earth Wire Assy.	1
19	AED043	REL-01	Thermostat Wire Assy	1
20	PA4021	REL-01	UK Cordset Assy. 3 Core 2m	1
21	PA6021	REL-01	Euro Cordset Assy. 3 Core 2m	1
22	PA8021	REL-01	USA Cordset Assy. 3 Core 2m	1
23	AED045	REL-02	230V Thermal Fuse / Switch Assy.	1
24	AED044	REL-02	120V Thermal Fuse / Switch Assy	1
25	EBX007	REL-01	Thermostat 185C	1
26	PA1058	REL-01	Retainer Ring	2
27	NDN055	REL-01	15mm Inlet Tube Spacer	1

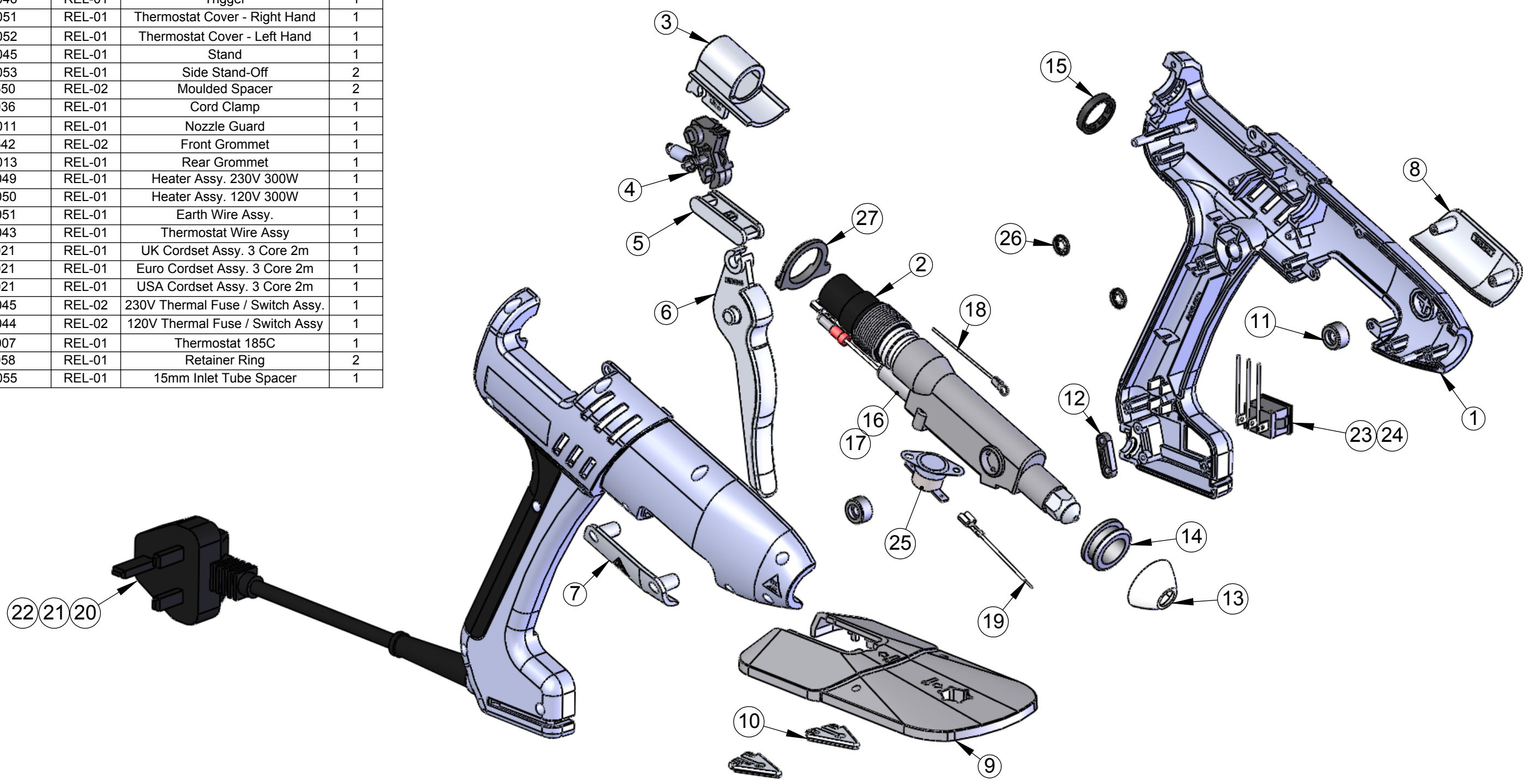

THIS DRAWING AND THE INFORMATION IT CONTAINS IS THE PROPERTY OF POWER ADHESIVES AND IS CONFIDENTIAL. IT MUST NOT BE REPRODUCED EITHER WHOLLY OR IN PART. ALL RIGHTS IN RESPECT OF PATENTS, DESIGNS AND COPYRIGHTS ARE RESERVED.

MATERIAL	N/A	DRAWN	SteveE
FINISH	N/A	DATE	10/05/07
COLOUR	N/A	ECR No.	00015

NOTES  
From S/N 12351 - 14192

DIMENSIONS ARE IN MM UNLESS OTHERWISE STATED	TOLERANCES UNLESS OTHERWISE STATED	SCALE	1:2
THIRD ANGLE	WHOLE NUMBERS ±0.5mm 1 DECIMAL PLACE ±0.3mm 2 DECIMAL PLACE ±0.1mm	SHEET	1 OF 1

TITLE	Tec 810-15	
DWG. No.	Tec 810-15	REVISION
A3		REL-02